

Photo Printer

User' s Manual

DS40

DS80

Version 1.02

Dai Nippon Printing Co., Ltd.

●Concerning Copyright

The copyrights for this document are the property of Dai Nippon Printing Co.,Ltd. Reproduction of any or all of the contents of this document without consent of the company is a violation of copyright law. However, one back-up copy may be made for non-commercial, personal purposes.

Also, the contents of this document are subject to change in the future without prior notice.

●Concerning Safety Warnings

Warnings concerning safety and use, and the contents of this document, conform to existing standards as of the date published.

●Concerning Modification

This printer was planned, developed, and manufactured by Dai Nippon Printing Co.,Ltd., and for safety purposes, any modification of the device is prohibited.

Introduction



Thank you for purchasing this device.
This document explains the handling and operation required to use this printer.
Please read this document well before use.
Be sure to read “For Safe Operation” (Pg 2-4), and operate the printer correctly.

For Safe Operation

- Be sure to read this document before use. After reading, keep it in a safe place, where it can be re-read as needed.
- The warnings listed here are to ensure proper use of the device, to prevent physical injury to the customer or other persons, and to prevent property damage. Please obey these warnings.



■ About “Warning” and “Caution”

Listed below, the possible levels of injury or damage due to misuse are categorized as “Warning” and “Caution”, according to the degrees of danger involved.

 Warning	Accidents caused by failure to heed the warnings accompanying this symbol could lead to serious or fatal injury.
 Caution	Accidents caused by failure to heed the warnings accompanying this symbol could lead to physical injury or property damage.

■ About the symbols

The symbols shown have the following meanings:

	This symbol calls attention to contents of warnings and cautions. Details are indicated in or near this symbol.
	This symbol indicates prohibited actions. The prohibited actions are detailed within the symbol.
	This symbol designates necessary actions, and relevant content. Details of the actions are shown within the symbol.



WARNING



- Use only with the designated voltage and frequency. Improper connection could cause electric shock or fire.
 - Avoid overstressing outlets and using extension cords. The outlet could overheat and cause a fire.
 - Do not damage, destroy, bundle, or alter the power cord. Also, placing heavy objects on, pulling on, or bending the cord excessively can damage it, and could cause a fire.
 - Do not set the printer up in places with salinity or corrosive gases in the air. This could cause a fire.
 - Do not block the vents. Heat could build up in the printer and cause a malfunction or fire.
 - Do not stand on or place heavy objects on the printer. Also, do not use excessive force on the buttons, switches, terminals, etc. This could break the printer and cause injury to the user or others.
 - Store the bag for the printer out of the reach of children. It could cause suffocation if placed over the head.
 - Be careful to avoid injury or damages from the edges in the printer.
 - Do not use this printer for applications where malfunction could be life-threatening (such as medical, space, aeronautic, or other applications that require extreme reliability).
-



- The printer weighs approximately 14 kg (31 lbs). When moving it, lift in a way that avoids excessive physical stress. Lifting recklessly or dropping the printer could cause injury.
 - Locate the printer as close to an outlet as possible, and allow easy access to unplug the power cord in case of problems.
 - If there is dust on the plug, clean it off thoroughly. It could cause electric shock or a short-out.
 - If metal objects or liquids have fallen into the printer, and there is smoke, a strange odor, or any other apparent abnormality, immediately turn the power OFF, and unplug the power cord. Then contact a service representative. Do not continue using the printer if it is not operating properly. This could cause shock, short circuit, or fire.
-



- Be sure to attach the ground. Otherwise, it could short-circuit, causing electric shock or fire.
-



- Do not plug or unplug the cord with wet hands. This could cause electric shock.
-



- Do not open the inside of the printer, disassemble internal parts, or modify the printer. It could cause electric shock, fire, or injury, or break the printer. For internal check-ups, adjustments, or repair, please contact a service representative.
-



CAUTION



- Do not set the printer up in dusty or overly humid places. This could cause fire or electric shock, or damage the printer.
- Do not set the printer up on an unstable surface. It could fall and cause injury to the user or others.
- Do not allow foreign objects to enter the printer. They could cause electric shock, short circuit, or fire, or break the printer. If something falls into the printer, immediately turn the power OFF, and call a service representative.
- Do not open the cover while printing. This could break the printer.
- Do not spill or spray liquids or chemicals into the printer.
- When cleaning the cover, do not use thinner, trichloroethane, benzene, ketone-based cleaners, or chemically treated cloths. They could discolor or deteriorate the cover.



- At least once a year, unplug the power cord, and clean the prongs and the plug. If dust accumulates, it could cause a fire.
- When printing continuously for long periods of time in a small room, be sure to ventilate properly.
- If use is intended on a transportation vehicle (train, truck, ship, etc.), please talk to a representative in advance.
- When disposing of the printer, peripheral items, packaging, or media, please abide by local waste removal ordinances. For details, contact your local government offices.



- When unplugging the cord, grip the plug. Do not pull on the cord. It could damage the cord, and cause electric shock or fire.
- When moving the printer, be sure to unplug the power cord. Otherwise, the cord may be damaged, which could cause fire or electric shock.
- When not using the printer for extended periods of time, for the sake of safety, be sure to unplug the power cord. It could cause electric shock or fire.



- Parts with this warning get extremely hot. Do not touch after printing. There is a danger of burns.



- Do not touch the gear mechanisms. There is a danger of injury if fingers get caught in the spinning gears.

WEEE MARK

If you want to dispose this product, do not mix with general household waste. There is a separate collection system for used electronics products in accordance with legislation under the WEEE Directive (Directive 2002/96/EC) and is effective only within European Union.

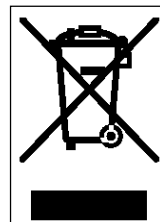

Cautions for Set-up

- Prior to operation, read “For Safe Operation” carefully and observe the rules therein.
- Use care when moving the printer. Never try carrying the printer alone.
Dropping it could cause injury or damage to other property.
- Do not use or store the printer near fire, excessive moisture, in direct sunlight, near an air conditioner or heater, or any other source of unusually high or low temperature or humidity, or excessive dust.
- Do not place the printer where chemical reactions occur, such as in a laboratory.
- Do not set up the printer where there is salinity or corrosive gas in the air.
- The printer must sit on a firm, level surface where there is ample ventilation.
- Do not put anything on the top of the printer.
- Do not place the printer near a radio or television, and do not use the same wall outlet for the printer and radio or television. Radio or television reception could be adversely affected.
- Do not use a power voltage or frequency other than those specified.
- Do not put anything on the power cord or step on it.
- Do not drag or carry the printer by the power cord or USB cable.
- Avoid plugging the power cord into an outlet with many loads.
- Do not bundle the power cord.
- Always grip the plug housing, not the cord, to plug/unplug the power cord.
- Make certain the power is turned off before connecting/disconnecting the USB cable.
- Avoid lengthening the signal cable or connecting it to any noise-producing device.
If it is unavoidable, use a shielded cable or twisted pair for each signal.
- Place the printer near the outlet where the power cord can be unplugged easily to shut off power.
- Use an AC outlet that accepts a three-pronged plug. Otherwise, there may be danger of electric shock.
- Use the appropriate specified cord set.
Only use items that are certified safe according to the standards of the country where they are to be used

●Japanese Users

Cord set No 5-AB0632-1

	Parts number	Rating	Acquired Standard No
Plug	KP-300	125V 12A	JET-1807-43001-1004
Cord	VCTF	1.25mm ² 3G	JET-2178-12009-1003
Connector	KS-16A	125V 12A	JET-1807-43004-1005

●American, Canadian Users

Cord set No INQ.1417

	Parts number	Rating	Acquired Standard No
Plug	CAT-009	125V 13A	UL:E69228 CSA:LL93534
Cord	SJT	1.25mm ² 3G	UL:E69167 CSA:LL97391 LL92902 LL42379
Connector	EF-28	125V 13A	UL:E69228 CSA:LL93534

Cord set No 5-AB0638

	Parts number	Rating	Acquired Standard No
Plug	KP-30	125V 13A	UL: E118569 CSA: LR84390
Cord	SJT	1.25mm ² 3G	UL: E42955 CSA: LL84512
Connector	KS-32	125V 13A	UL: E118569 CSA: LL84391

●European Users

Cord set No 764S

	Parts number	Rating	Acquired Standard No
Plug	203	10/16A 250V	EN60799
Cord	H05VV-F	1.00mm ² 3G	EN60799
Connector	EF-28	250V 10A	EN60799

Cord set No 764S

	Parts number	Rating	Acquired Standard No
Plug	KP-4819Y	10 / 16A 250V	IEC60884
Cord	H05VV-F(GTCE-3)	1.00mm ² 3G	IEC60227-5
Connector	KS-31A	250V 10A	IEC60320-1

● South Korea Users

Cord set No 764S

	Parts number	Rating	Acquired Standard No
Plug	203	16A 250V	K60884-1,KSC8305
Cord	H05VV-F	1.00mm ² 3G	K60227-5,K60227-1,K60227-2
Connector	EF-28	250V 10A	K60320-1

● Taiwan Users

Cord set No INQ.2978 (146+EF-28)

	Parts number	Rating	Acquired Standard No
Plug	146	125V 11A	CI315064230155
Cord	HVCTF	1.25mm ² 3C	CI315064230155
Connector	EF-28	125V 11A	CI315064230155

Cord set No PT6Y1I2I20A-067(LP-71/LS-32)

	Parts number	Rating	Acquired Standard No
Plug	LP-71	125V 10A	CI313068120111
Cord	VCTF	1.25mm ² 3C	CI313068120111
Connector	LS-32	125V 10A	CI313068120111

Regulatory compliance statements

American users

FCC part 15

This equipment has been tested and found to comply with the limits for a Class B digital device, pursuant to Part 15 of the FCC Rules. These limits are designed to provide reasonable protection against harmful interference in a residential installation. This equipment generates, uses and can radiate radio frequency energy and, if not installed and used in accordance with the instructions, may cause harmful interference to radio communications. However, there is no guarantee that interference will not occur in a particular installation. If this equipment does cause harmful interference to radio or television reception, which can be determined by turning the equipment off and on, the user is encouraged to try to correct the interference by one or more of the following measures:

- Reorient or relocate the receiving antenna
- Increase the separation between the equipment and receiver
- Connect the equipment into an outlet on a circuit different from that to which the receiver is connected
- Consult the dealer or an experienced radio/TV technician for help

You are cautioned that changes or modifications not expressly approved by the party responsible for compliance could void your authority to operate the equipment

This device complies with FCC radiation exposure limits set forth for an uncontrolled environment. The antenna used for this transmitter must be installed to provide a separation distance of at least 20 cm from all persons and must not be co-located or operating in conjunction with any other antenna or transmitter.

Caution: Use shielded cables to connect this computers.

Any changes or modifications not expressly approved by the grantee of this device could void the users authority to operate the equipment.

日本のお客様へ／Japanese Users

電波障害について

この装置は、情報処理装置等電波障害自主規制協議会（VCCI）の基準に基づくクラス B 情報技術装置です。この装置は、家庭環境で使用することを目的としていますが、この装置がラジオやテレビジョンの受信機に近接して使用されると、受信障害を引き起こす可能性があります。

取扱説明書に従って正しい取り扱いをして下さい。

VCCI statement

This equipment is in the Class B category (information Technology Equipment to be used in a residential area or an adjacent area thereto) and conforms to standards set by the Voluntary Control Council for interference by information Technology Equipment aimed at preventing radio interference in such residential areas. When used near a radio or TV receiver, it may become the cause of radio interference. Read instructions for correct handling.

Declaration of Conformity

European users

The hereinafter mentioned product is manufactured according to Internal Production Control and Specific Apparatus Tests in compliance with

ANNEX III of the R&TTE-Directive 99/05/EC

Product: DS40/DS80
Photo Printer

The presumption of conformity with the essential requirements regarding Council Directive 99/05/EC is ensured according to

Art. 3.1 a)	Safety:	EN 60950-1: 2001 EN 50364: 2001 (equivalent to 73/23/EEC & 93/68/EEC)
Art. 3.1 b)	EMC:	ETSI EN 301 489-1 V1.6.1 (2005-09) ETSI EN 301 489-3 V1.4.1 (2002-08) (equivalent to 89/336/EC)
Art. 3.2)	Radio:	EN 300 330-1 V1.3.2: (2002-12) EN 300 330-2 V1.3.1: (2006-04)

The product bears the European Approvals Marking "CE".
Due to Class 1 categorized, alert mark to indicate using non-harmonized frequency and Notification to National Authorities according to Article 6.4 are not needed.

English

Hereby, Dai Nippon Printing Co.,Ltd. declares that this DS40/DS80 is in compliance with the essential requirements and other relevant provisions of Directive 1999/5/EC.

Finnish

Dai Nippon Printing Co.,Ltd. vakuuttaa täten että DS40/DS80 tyyppinen laite on direktiivin 1999/5/EY oleellisten vaatimusten ja sitä koskevien direktiivin muiden ehtojen mukainen.

Dutch

Hierbij verklaart Dai Nippon Printing Co.,Ltd. dat het toestel DS40/DS80 in overeenstemming is met de essentiële eisen en de andere relevante bepalingen van richtlijn 1999/5/EG

Bij deze verklaart Dai Nippon Printing Co.,Ltd. dat deze DS40/DS80 voldoet aan de essentiële eisen en aan de overige relevante bepalingen van Richtlijn 1999/5/EC.

French

Par la présente Dai Nippon Printing Co.,Ltd. déclare que l'appareil DS40/DS80 est conforme aux exigences essentielles et aux autres dispositions pertinentes de la directive 1999/5/CE.

Par la présente, Dai Nippon Printing Co.,Ltd. déclare que ce DS40/DS80 est conforme aux exigences essentielles et aux autres dispositions de la directive 1999/5/CE qui lui sont applicables.

Swedish

Härmed intygar Dai Nippon Printing Co.,Ltd. att denna DS40/DS80 står i överensstämmelse med de väsentliga egenskapskrav och övriga relevanta bestämmelser som framgår av direktiv 1999/5/EG.

Danish

Undertegnede Dai Nippon Printing Co.,Ltd. erklærer herved, at følgende udstyr DS40/DS80 overholder de væsentlige krav og øvrige relevante krav i direktiv 1999/5/EF

German

Hiermit erklärt Dai Nippon Printing Co.,Ltd., dass sich dieser/diese/dieses DS40/DS80 in Übereinstimmung mit den grundlegenden Anforderungen und den anderen relevanten Vorschriften der Richtlinie 1999/5/EG befindet".(BMW)

Hiermit erklärt Dai Nippon Printing Co.,Ltd. die Übereinstimmung des Gerätes DS40/DS80 mit den grundlegenden Anforderungen und den anderen relevanten Festlegungen der Richtlinie 1999/5/EG.(Wien)

Greek

ΜΕ ΤΗΝ ΠΑΡΟΥΣΑ Dai Nippon Printing Co.,Ltd. ΔΗΛΩΝΕΙ ΟΤΙ DS40/DS80 ΣΥΜΜΟΡΦΩΝΕΤΑΙ ΠΡΟΣ ΤΙΣ ΟΥΣΙΩΔΕΙΣ ΑΠΑΙΤΗΣΕΙΣ ΚΑΙ ΤΙΣ ΛΟΙΠΕΣ ΣΧΕΤΙΚΕΣ ΔΙΑΤΑΞΕΙΣ ΤΗΣ ΟΔΗΓΙΑΣ 1999/5/ΕΚ

Italian

Con la presente Dai Nippon Printing Co.,Ltd. dichiara che questo DS40/DS80 è conforme ai requisiti essenziali ed alle altre disposizioni pertinenti stabilite dalla direttiva 1999/5/CE.

Spanish

Por medio de la presente Dai Nippon Printing Co.,Ltd. declara que el DS40/DS80 cumple con los requisitos esenciales y cualesquiera otras disposiciones aplicables o exigibles de la Directiva 1999/5/CE.

Portuguese

Dai Nippon Printing Co.,Ltd. declara que este DS40/DS80 está conforme com os requisitos essenciais e outras disposições da Directiva 1999/5/CE.

Malti

Hawnhekk, Dai Nippon Printing Co.,Ltd., jiddikjara li dan DS40/DS80 jikkonforma mal-htigijiet essenzjali u ma provvedimenti oħrajn relevanti li hemm fid-Dirrettiva 1999/5/EC

사용자 안내

이 기기는 B 급 기기(가정용 정보통신기기)입니다.

기기는 가정용으로서 전자파 적합등록을 마친 기기이며, 주거지역에서는 물론 전 지역에서 사용 가능합니다.

Table of Contents

<i>Introduction</i>	2
<i>For Safe Operation</i>	2
<i>Cautions for Set-up</i>	5
<i>Regulatory compliance statements</i>	8
<i>Declaration of Conformity</i>	9
<i>사용자 안내</i>	12
<i>Table of Contents</i>	13
<i>Setting Up the Printer</i>	14
<i>Checking the Contents</i>	14
<i>Names of Components</i>	15
<i>Connecting the Power Cord</i>	16
<i>Connecting to the Computer</i>	16
<i>Paper and Ribbon</i>	17
<i>Setting the Media</i>	18
<i>Trouble-shooting</i>	23
<i>Error Displays</i>	23
<i>Solving Media Errors</i>	24
<i>Cleaning</i>	28
<i>Platen Roller</i>	28
<i>Specifications</i>	29

Checking the Contents

Please check that the printer and all accessories are included in the package.

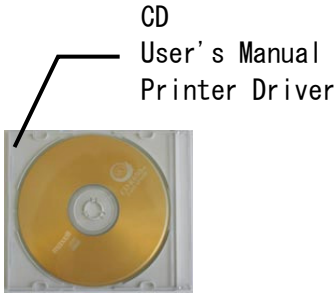
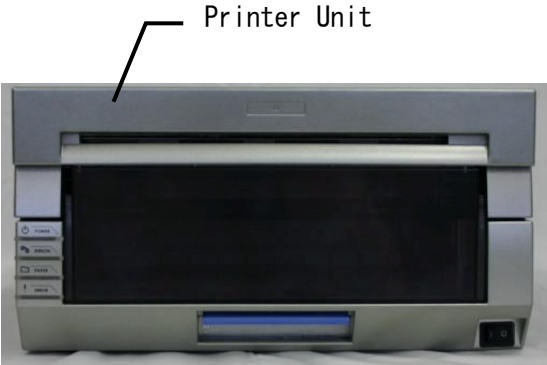

Paper Holder
(Set in the printer)
* Remove wrapping before use

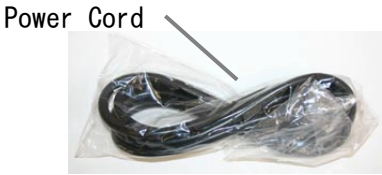

Paper Cassette
(Set in the printer)



Ribbon Cassette
(Set in the printer)



CAUTION

- When removing the printer from its package, carrying it, or moving it, be sure to use care. Dropping the printer could result in personal injury or damage to other items.
- If the printer is lifted by grasping the cushions, the cushions could break and cause the printer to be dropped.

Names of Components

[Front of Unit]

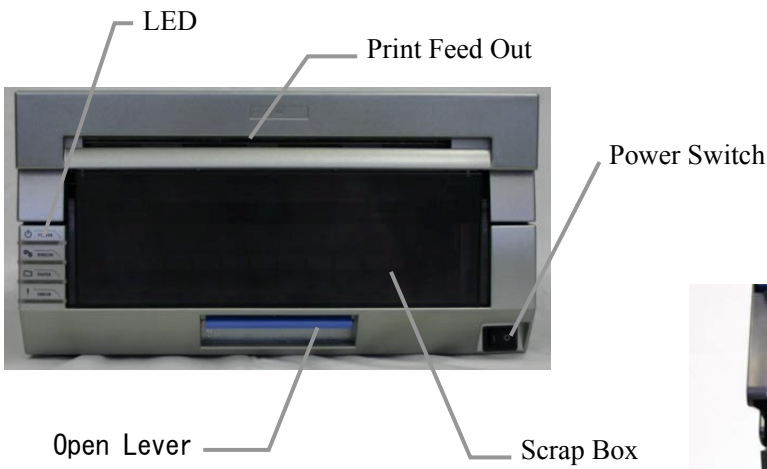

Platen Roller

[Back of Unit]

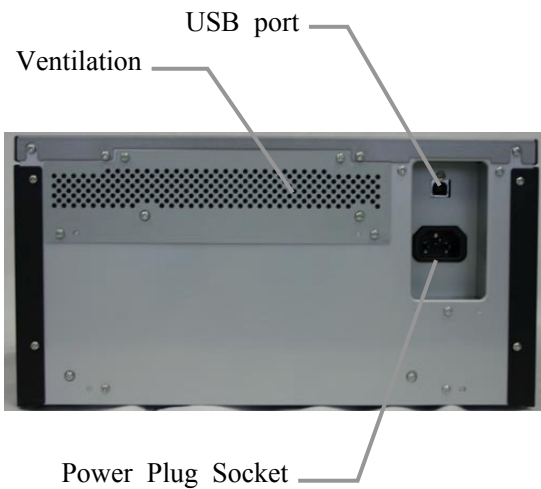

[Side of Unit]



Ventilation



CAUTION

- Please be careful not to hurt yourself or damage anything on the edges of the printer.

Connecting the Power Cord

1. Make sure that the printer's power switch is set to the OFF position.
2. Plug the cord connector end into the printer Power Plug Socket.
3. Plug the cord into the wall outlet.



Connecting to the Computer







1. Make sure that both the printer and computer power switches are set to the OFF position.
2. Connect the USB cable to the printer and the computer.
3. Turn on the power.

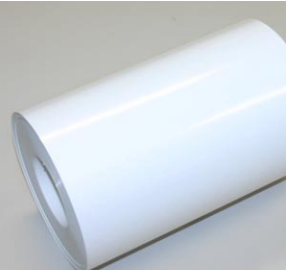
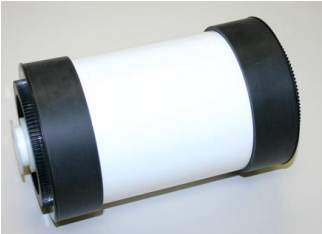

CAUTION

- Please use the power cable that came with the printer, and be sure to attach the ground wire.

Paper and Ribbon

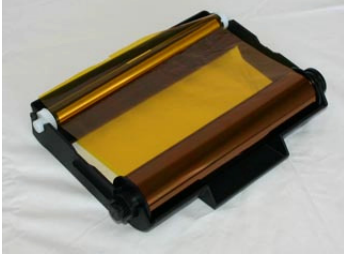
	DS40		DS80
Type	L, 2L	PC, A5W	8*10, 8*12
Paper			
			
	Width: 127mm	Width: 152mm	Width: 203mm
Ribbon			
	Width: 134mm	Width: 159mm	Width: 210mm



CAUTION

- Set the paper and ribbon without putting them directly on the work surface. Any dust or dirt could get inside the printer and adversely affect the print quality.

Setting the Media

1. Release the Open Lever, and pull out the mechanism unit.



Open Lever

2. Open the Paper Release lever.

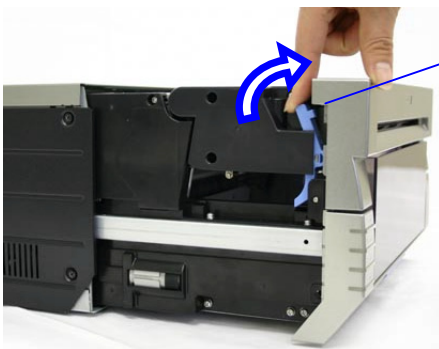

Paper Release Lever

3. Remove the scrap box



Scrap Box

4. Remove the entire paper cassette unit.



Setting Up the Printer

5. Install the new roll of paper on the paper holder.
When installing it, make sure there are no gaps between the paper and the holder.
Make sure the paper is not sticking out. If the end of the roll is uneven (with paper sticking out), remove it from the holder, and flatten it.

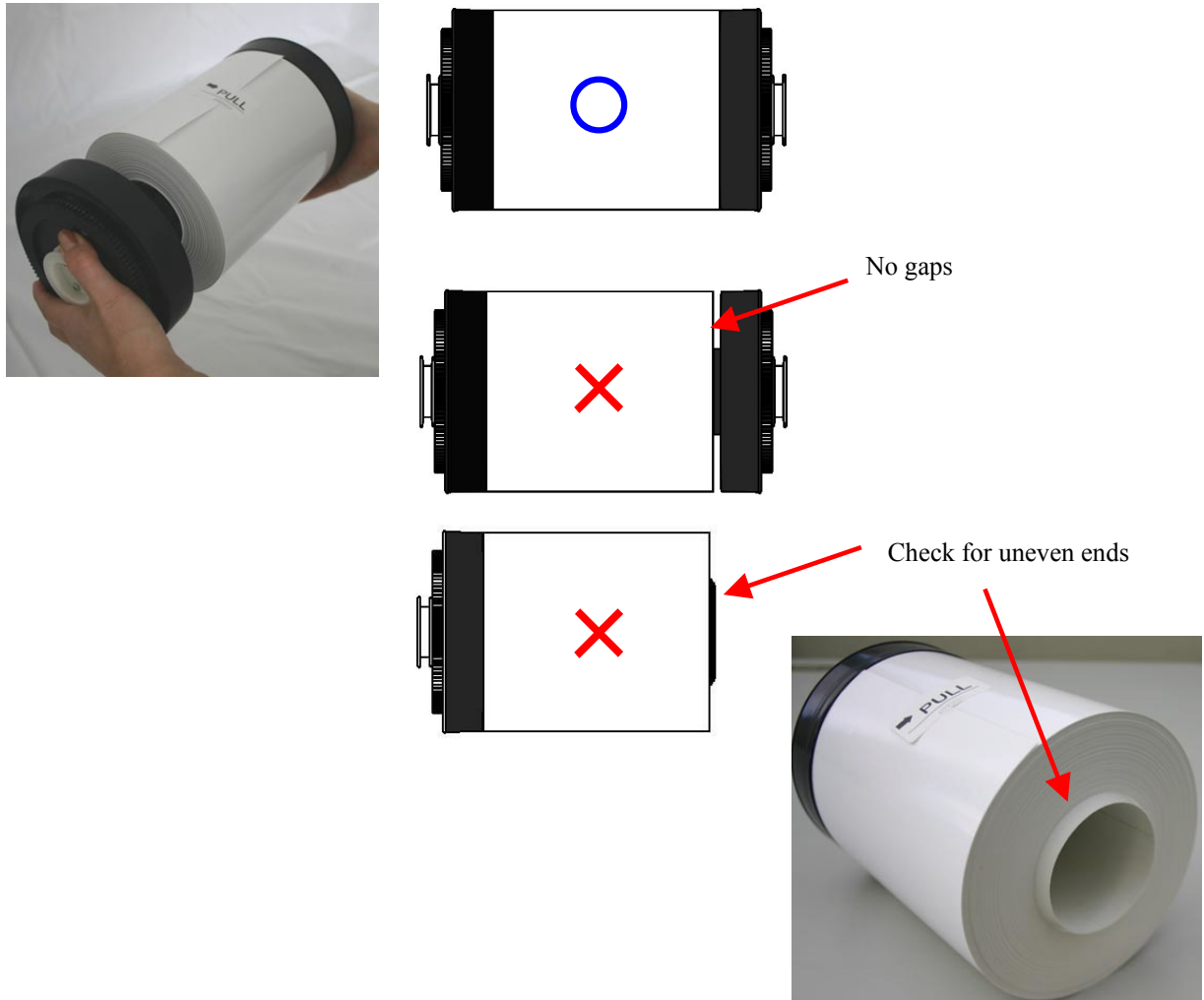

6. Set the paper holder into the paper cassette. ((Set it firmly all the way in)
Set the paper in the direction indicated below.

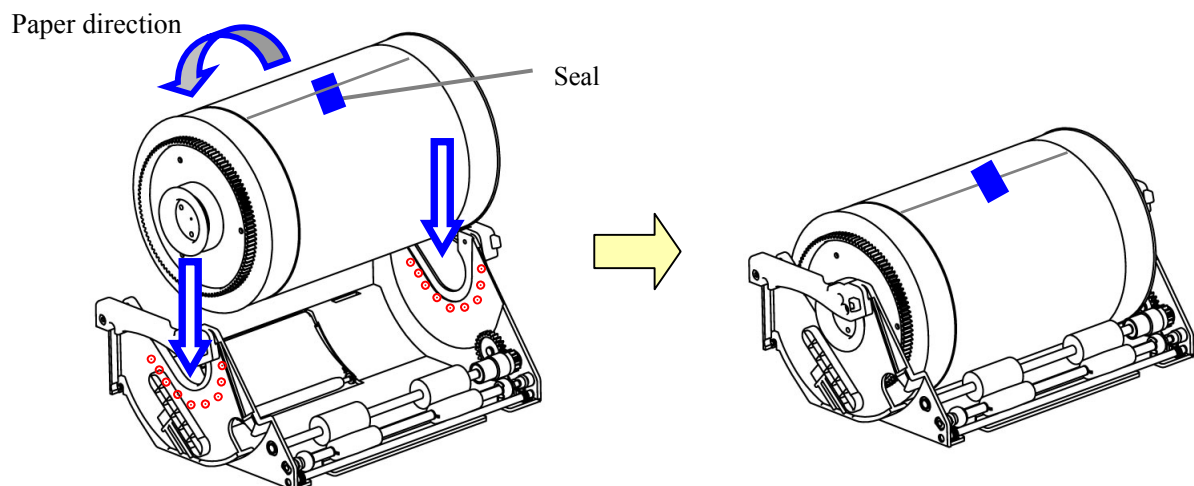

Setting Up the Printer

7. Remove the tape, and advance the roll as indicated by the arrow. Set the end of the paper about 5mm beyond the roller. When doing this, insert the paper straight along the seal. If it isn't inserted straight, the paper will be crooked, which could cause white line on the edges of the print, ribbon wrinkles, and register slippage.

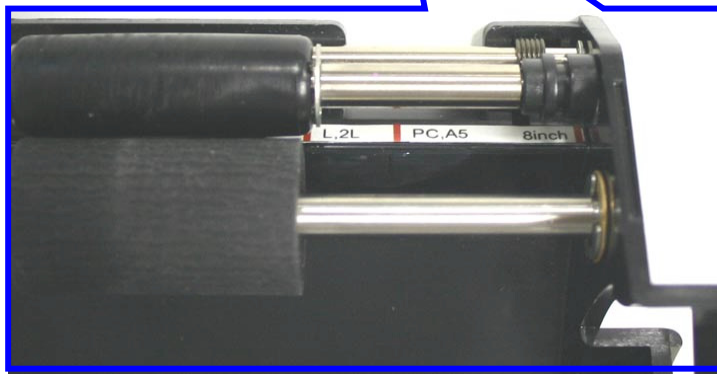
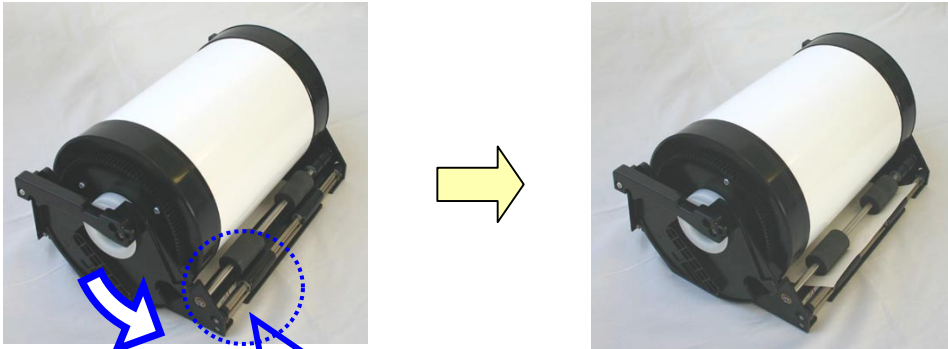

Path of the paper

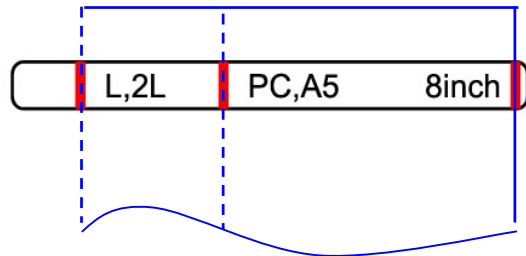

As seen from above

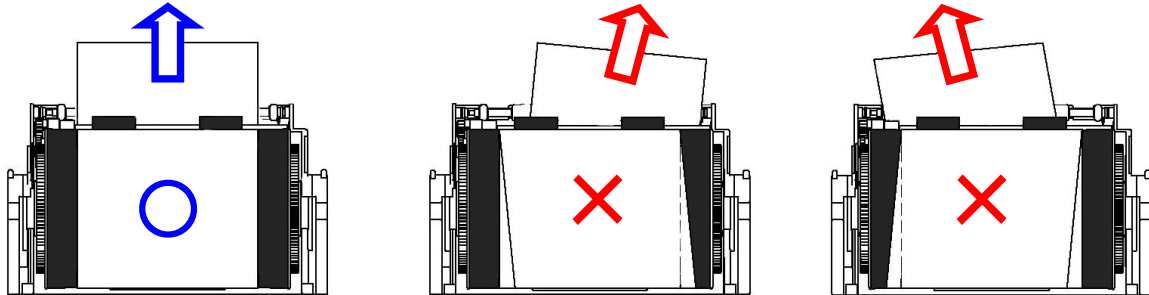

8. Set the paper cassette into the printer.

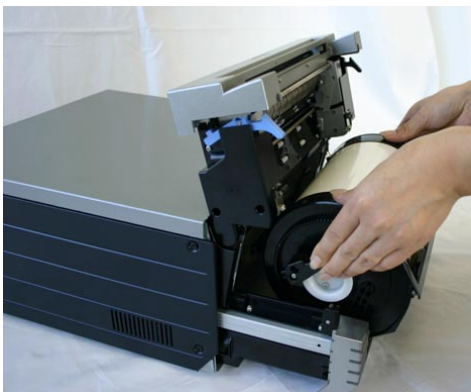

Setting Up the Printer

9. Turn the paper in the direction of the arrow. When it is advanced enough, the buzzer will beep, and the flashing LED (orange) will go out.
It is easier to set if the paper is turned while securing the holder with one hand.

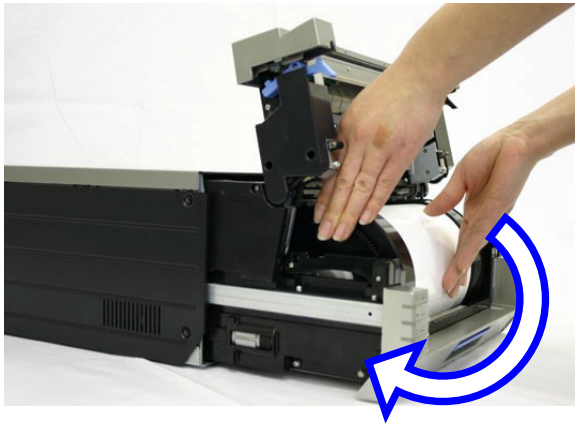

10. Set the scrap box, and close the cover.
The printer will not operate without the scrap box.
If the mechanism unit is closed without the scrap box attached, there will be a “No Scrap Box Error”, and the LED will flash (red).



CAUTION

- The printer will not operate without the scrap box attached.
- When the scrap box is removed, do not insert your fingers in the cutter at the top. They could be cut or severed.
- As prints are cut, the scrap box fills with scrap paper. Be sure to empty it when you change the paper and ribbon. If it becomes over-filled with scraps, it could cause problems with the printer.

Setting Up the Printer

11. Set the new ribbon into the ribbon cassette.
Advance the ribbon in the direction of the arrow, and take up any slack.

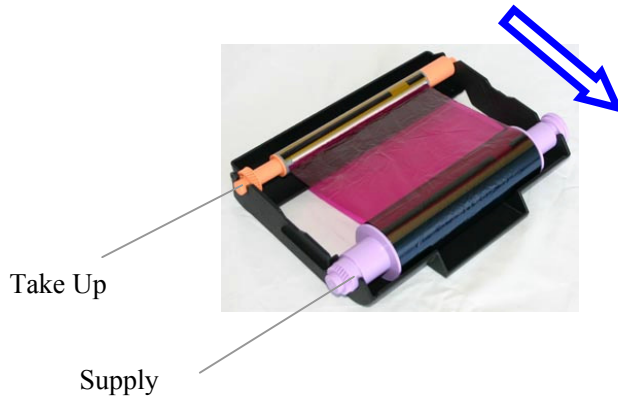

12. Set it with the supply side in front.

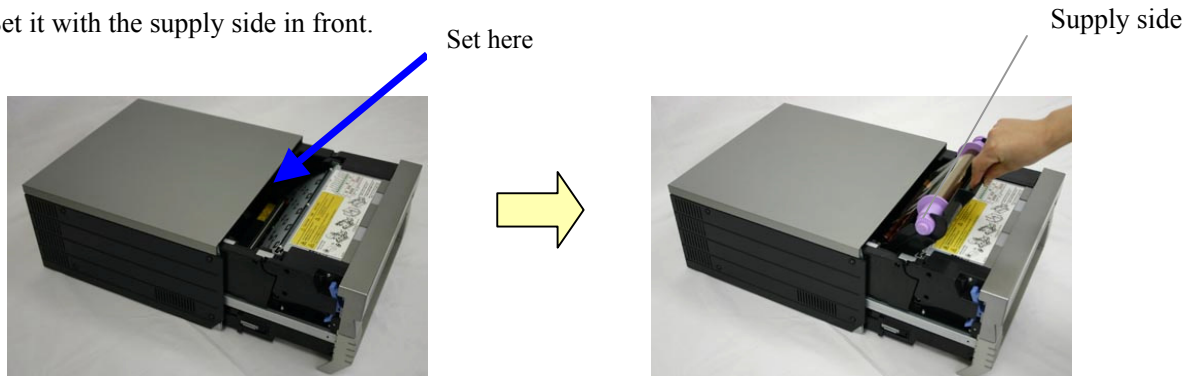

13. Close the mechanism unit.

*When the mechanism unit is closed, the printer will run initialization (4 blank sheets will be fed out). However, if the power is turned ON after the paper is set, it won't run the initialization. By running initialization, the dirty outer layer of paper is cut off.



*In order to facilitate media color adjustment, media type recognition, and print quantity management, an IC chip is built into the ink ribbon. Media without an IC chip, which has not been evaluated and cleared, may not function properly. (If correct data cannot be read from the IC chip, an alarm will sound. In this case, in order to protect the printer, it will lower the concentration for printing.)

*Please change the media as a set, because the IC chip for each ribbon has unique information. Otherwise, errors could occur.

*If different width media (for example L-size and PC-size) are used on the same printer, problems with the print quality could arise. Therefore, it is preferable not to mix the use of different width media on one printer.



CAUTION

- Replace the ribbon and paper as a set to avoid problems later.

Error Displays



The flashing LED indicates the printer status

Status	LED display				Solution	Refer to
	Power	Ribbon	Paper	Error		
Paper End *1	●		★		Put in a new roll of paper	P.18
Ribbon End *1	●	★			Put in a new roll of ribbon	P.22
Door is Open (no paper)	●		★	★	Set the paper properly and close the mechanism unit	P.18
Door is Open	●			★	Close the mechanism unit	P.22
No Scrap Box	●			★	Set the scrap box	P.21
Paper Error	●		●	●	Free the paper, and reset it correctly	P.24
Ribbon Error	●	●		●	Fix the ribbon, and set it correctly	P.26
System Error *2	●			●	Re-boot the printer (turn off, then on)	—
Head Cool Down	★				The head is cooling off (auto-recovery)	—

* ● indicates lit, ★ indicates flashing, and blank is not lit

*1 Exchange the paper and ribbon as a set.

*2 If the system error cannot be corrected, contact the dealer.

Solving Media Errors

1. Pull out the mechanism unit.



2. Remove the ribbon cassette.



- a. If the paper is jammed:



1. Pull any paper remaining in the printer in the direction shown, and cut off any wrinkled or partially printed areas evenly with scissors.
Printing over an already printed area will cause the ribbon to stick, and the paper will jam again.
When pulling the paper out, pull it slowly. Application of too much force could damage the printer.



CAUTION

- Please be careful not to hurt yourself or damage anything on the edges of the printer.

2. Remove the scrap box, and rewind the paper.



3. Cut off any partially printed, wrinkled, or otherwise inferior paper evenly with a pair of scissors, and reset the paper. If wrinkles or partially printed areas are left, it could cause the paper to jam again.



Cutting the paper

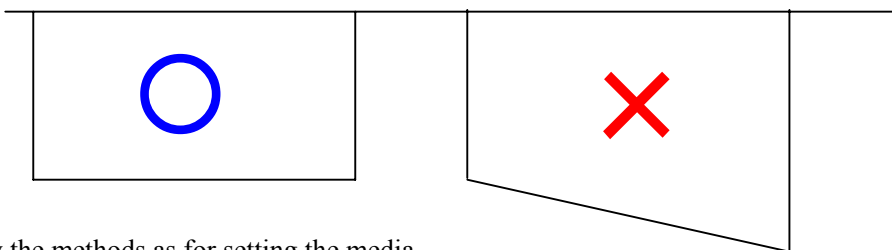

Then follow the methods as for setting the media.

b. If the ribbon is pulled into the mechanism:



1. Cut the ribbon.

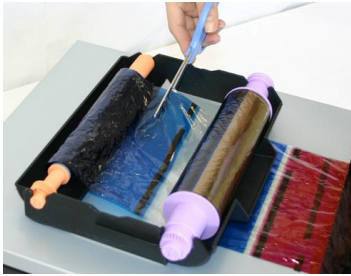

2. Carefully remove any ribbon remaining in the mechanism.
Any pieces of ribbon left inside the mechanism could affect print quality.
In this case, clean the platen roller see P.28



3. Reattach the ribbon with cellophane (or similar) tape.



Tape

4. Rotate the up-take ribbon several times until the tape is out of sight. Take care that there is no slack in the ribbon.

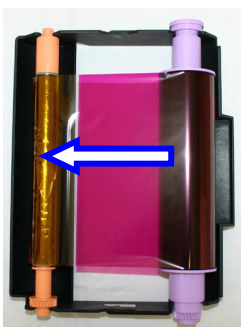

Then, refer to a. If the paper is jammed.

c. If the printer is stopped in the middle of cutting:



1. Turn the power back ON. Free the jammed paper, and return the cutter blade to its ready position.

If the jammed paper cannot be freed, please contact a service representative.

2. Remove any partially printed material from inside the mechanism unit.
Then, refer to [a. If the paper is jammed.](#)

d. If power is cut during printing:

*If the power is cut during printing, you will not be able to pull out the mechanism unit.

1. Turn the power back ON. The partial print will be cut into scrap-size pieces and removed.
After this, you will be able to pull out the mechanism unit.
2. Check that there is no printed material in the mechanism unit.
If the paper is jammed, refer to [a. If the paper is jammed.](#)



CAUTION

- Do not turn the power OFF while printing. This could damage the printer.

Platen Roller

If there is an indent on the pictures at a regular interval, or if the back of the picture (white side) is dirty, clean the platen roller.

There may be dust, grime, adhesives, etc. from the ribbon or paper on the platen roller.

1. Prepare a piece of gauze or other soft cloth soaked in ethyl alcohol.
Benzenes or thinners other than ethyl alcohol may permeate the resin, so they should not be used.
2. Wipe off any grime while turning the platen roller.

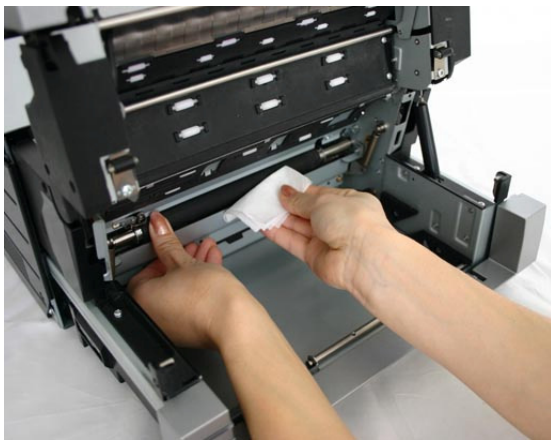

CAUTION

- Please be careful not to hurt yourself or damage anything on the edges of the printer.
- Never use benzenes or thinners other than ethyl alcohol, as they may permeate the resin.

Specifications

Model		DS40			DS80	
Print type		Thermal dye sublimation transfer				
Print mode		High-speed mode	High quality mode		High-speed mode	High quality mode
Resolution		300 × 300dpi	300 × 600dpi		300 × 300dpi	300 × 600dpi
Print size	L	89*127mm		8*4	203 × 102mm	
	PC	101*152mm		8*5	203 × 127mm	
	2L	127*178mm		8*6	203 × 152mm	
	A5	152*203mm		8*8	203 × 203mm	
	A5W	152*229mm		8*10	203 × 254mm	
					8*12	203 × 305mm
Print sheet	L	400 sheets		8*10	130 sheets	
	PC	400 sheets		8*12	110 sheets	
	2L	230 sheets				
	A5W	180 sheets				
Print time	L	Approx. 8.4 sec	Approx. 10.8 sec	8*10	Approx. 30.2 sec	Approx. 40.2 sec
	PC	Approx. 8.9 sec	Approx. 11.7 sec	8*12	Approx. 35.2 sec	Approx. 46.2 sec
	2L	Approx. 12.8 sec	Approx. 17.4 sec			
	A5W	Approx. 13.9 sec	Approx. 19.3 sec			
	8*12	Approx. 16.4 sec	Approx. 22.4 sec			
Ribbon type		YMC + overcoat				
Interface		USB2.0				
Driver-compatible OS		Windows 2000/XP				
Dimensions		322mm W × 366mm D × 170mm H				
Weight		Approx. 14 kg (printer only)				
Power		AC100V—240V 50/60Hz				
Power consumption		100V 3.96A 240V 1.69A				
Noise		A-weighted sound pressure level < 70dB: “less than 70 dB”				
Operating environment		Temp. 5~35°C in natural conditions				
		Humidity 35~80 with no condensation				

* These specifications may be changed without prior notice.

Information on servicing the printer

For questions regarding operation and servicing of the printer, contact the dealer where the printer was purchased, or consult at the following:

DNP Photo Marketing Co.,Ltd.
<http://www.dnp-photomarketing.com/>